



# Cobra® HH50 WX ST

## The CB Story

### If You Think You Need Service

For technical assistance, please call our Automated Help Desk which can assist you by answering the most frequently asked questions about Cobra products.

**(773) 889-3087**

24 hours a day, 7 days a week.

A Consumer Service Representative can be reached through this same number 8:00 am - 5:30 pm, Monday through Friday, Central Time.

Technical assistance is also available on-line in the Frequently Asked Questions (FAQ) section at [www.cobra.com](http://www.cobra.com) or by e-mail to [productinfo@cobra.com](mailto:productinfo@cobra.com)

If you think you need service call 1.773.889.3087

"If your product should require factory service please call Cobra first before sending your unit in. This will ensure the fastest turn-around time on your repair."

You may be asked to send your unit to the Cobra factory. It will be necessary to furnish the following in order to have the product serviced and returned.

1. For Warranty Repair include some form of proof-of-purchase, such as a mechanical reproduction or carbon or a sales receipt. If you send the original receipt it cannot be returned.
2. Send the entire product.
3. Enclose a description of what is happening with the unit. Include a typed or clearly print name and address of where the unit is to be returned.
4. Pack unit securely to prevent damage in transit. If possible, use the original packing material.
5. Ship prepaid and insured by way of a traceable carrier such as United Parcel Service (UPS) or First Class Mail: to avoid loss in transit to: Cobra Factory Service, Cobra Electronics Corporation, 6500 W. Cortland St., Chicago, IL 60707.
6. If the unit is in warranty, upon receipt of your unit it will either be repaired or exchanged depending on the model. Please allow approximately 3 to 4 weeks before contacting us for status. If the unit is out of warranty a letter will automatically be sent informing you of the repair charge or replacement charge. If you have any questions, please call 1.773.889.3087 for assistance.

### Trademark Info

Cobra®, Dynamike®, Nothing Comes Close to a Cobra® SoundTracker®, and the snake design are registered trademarks of Cobra Electronics Corporation, USA.

Cobra Electronics Corporation™ is a trademark of Cobra Electronics Corporation, USA.

The Bluetooth® word mark and logo are registered trademarks owned by Bluetooth SIG, Inc.

### Operating Instructions for your Cobra HH 50 WX ST

## Citizens Band 2-Way Handheld CB Radio

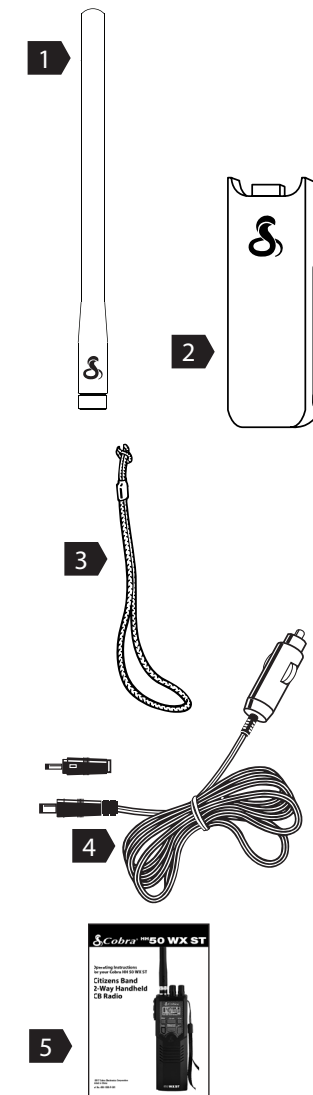

The Citizens Band lies between the shortwave broadcast and 10-meter Amateur radio bands, and was established by law in 1949. The Class D two-way communications service was opened in 1959. (CB also includes a Class A citizens band and Class C remote control frequencies.)

### What's Included with Your HH 50 WX ST

1. High Efficiency Antenna
2. Removable Belt Clip
3. Wrist Strap
4. 12 Volt Cigarette Lighter Plug & Charge Adapter
5. Operating Manual

© 2017 Cobra Electronics Corporation  
Printed in China

Part No. 480-1088-P-001 Version D



## Controls and Indicators

1. BNC Antenna Connector
2. Squelch Control
3. On/Off Volume Control
4. Removable Belt Clip
5. External Speaker Jack
6. External Microphone Jack
7. Charge LED
8. Rechargeable Battery Charge Jack
9. DC Power Jack
10. Light Key
11. Channel Up/Down Keys
12. PTT (Push To Talk) Key
13. Battery Door/Chamber
14. LCD Display Panel
15. Lock Key
16. SoundTracker® Key
17. CB/WX Weather Key and HI/LO Power Saver Key
18. Instant Channel 9 & 19 and Dual Watch Key
19. Program Key
20. Channel Scan
21. Microphone

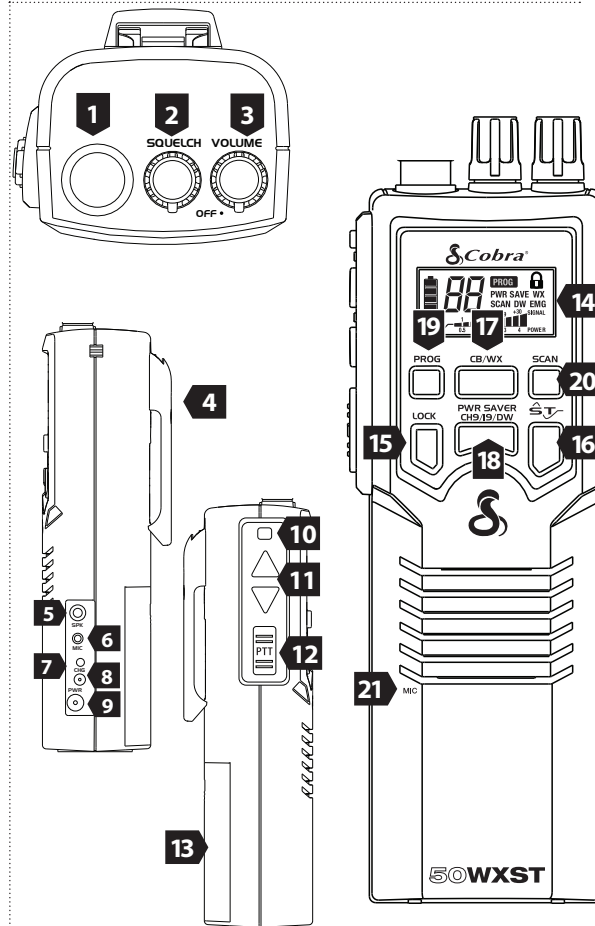

## Our Thanks to You

Thank you for purchasing the Cobra HH 50 WX ST handheld CB. Properly used, this Cobra product will give you many years of reliable service.

### SoundTracker®

“Cuts noise coming in...strengthens signals going out.”

This technology dramatically improves transmission and reception of the CB signals.

The revolutionary SoundTracker® System reconfigures the transmission signal which allows it to be transferred more efficiently through cluttered airwaves.

At the same time, it significantly reduces the amount of static on all incoming CB signals.

The end result is a cleaner, clearer sounding reception of signals and a more powerful transmission which dramatically improves CB communications.

### Customer Support

Should you encounter any problems with the product or not understand its many features, please refer to this owner's manual. If, after referring to the manual, you still need help, call Cobra Customer Service at 773-889-3087.

### Cobra Customer Service

Live operators are available  
M-F 8:00 am - 5:30 pm Central  
Time at:  
773-889-3087

Automated Technical  
Assistance is available 24 hours  
a day, seven days a week.  
E-mail questions to:  
[productinfo@cobra.com](mailto:productinfo@cobra.com)

Frequently Asked Questions  
(FAQ) can be found on-line at:  
[www.cobra.com](http://www.cobra.com)

## Contents

<b>Features</b> .....	1
<b>The CB Story</b> .....	A1
Included Accessories	
<b>Controls &amp; Indicators</b> .....	A2
<b>Our Thanks to You</b> .....	A3
SoundTracker® System	
Customer Support	
<b>Operating Your HH 50 WX ST</b>	
Antenna.....	2
Battery Installation .....	3
Belt Clip .....	3
Turning on Your CB.....	4
Setting Squelch .....	4
Selecting a Channel .....	6
LCD Display .....	7
Transmit/Receive .....	8
One Touch Channel 9 & 19 .....	10
All Channel Scan .....	11
Dual Watch.....	12
Weather Channels .....	14
Power High/Low .....	16
Battery Capacity Level.....	18
SoundTracker® System .....	19
Illuminated Display .....	23
Lock Key .....	24
In Vehicle Use.....	25
<b>How Your CB Can Serve You</b> .....	26
A Few Rules You Should Know .....	26
Weather Channel Messages.....	27
Channel 9 Emergency Messages .....	28
CB 10 Codes.....	30
<b>Frequency Ranges</b> .....	32
<b>HH 50 WX ST Specifications</b> .....	33
<b>Warranty Information</b> .....	34
<b>Optional Accessories</b> .....	35
<b>FCC</b> .....	36
<b>If You Think You Need Service</b> .....	Back Cover

## Features of This Product

- 40 CB Channels
- 10 Weather Channels
- Full Feature LCD Display
- Dual Channel Watch
- Full Channel Scan
- Battery Level Meter
- External Speaker/  
Microphone Jack
- Instant Channel 9 & 19
- High/Low Power Saver  
Switch
- BNC Antenna Connector
- Lock Key
- Battery Charge Jack
- Battery Charge LED

## Attach Antenna

### Note

To increase range as a portable, use HA-TA telescopic loaded long range antenna. (See Accessory Page 35).

## Attach the Antenna

- 1 Insert.

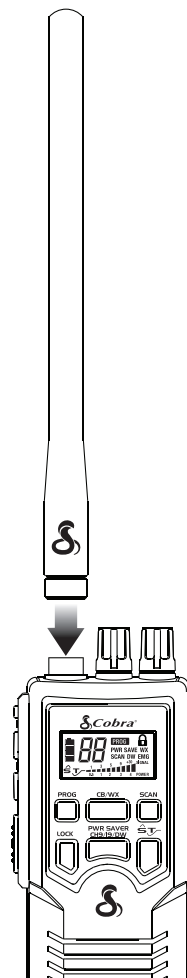

- 2 Turn clockwise. ¼ turn.



## Install the Batteries

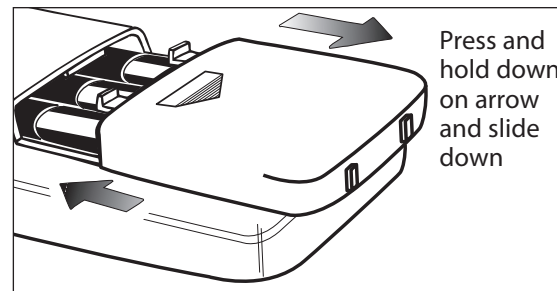

Press and hold down on arrow and slide down

- 1 To remove battery chamber cover, press down on the arrow and slide down.
- 2 Install the batteries by polarity markings.
- 3 Replace cover.

NiMH rechargeable batteries should be charged a minimum of 12 hours with a CA-45CB charger.

## Attach the Belt Clip

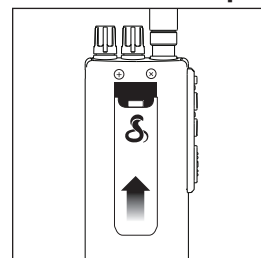

- 1 Slide the belt clip up on the rails of the base until tab locks.

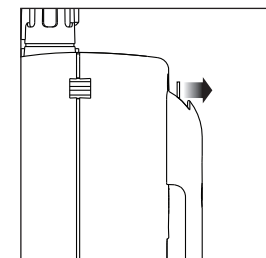

- 2 To remove the belt clip, lift the tab out and slide the belt clip down.

## Battery Installation

### Note

Ignoring polarity markings (+/-) may cause damage to both the unit and the batteries.

**The HH 50 WX ST requires 9 "AA" alkaline or NiMH batteries rated at 1000 mAh (not included with the unit).**

When the batteries are low or need charging the BATTERY icon will flash on the LCD display. Replace alkaline batteries or recharge NiMH batteries.

NiMH rechargeable batteries should be charged a minimum of 12 hours with a CA-45CB charger. NiMH rechargeables should have a rating of 1.2 vdc, 1000 mAh.

## Attach the Belt Clip

## Turning On

### Note

Make sure the antenna is installed on the radio.

### Note

When you turn on the HH 50 WX ST, a series of tones will be heard and the icons will briefly appear on the LCD display.

LCD lights on for 5 seconds, then turns off.

## Turning On

Rotate ON - OFF Volume Control *clockwise*.

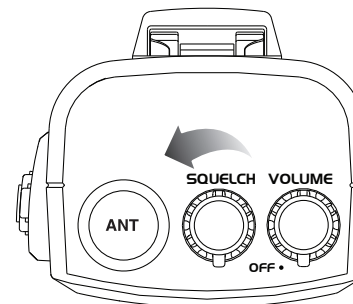
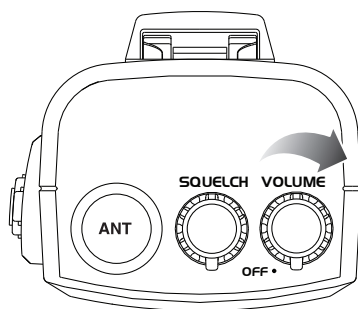

- Fully *counterclockwise* opens the "gate" and all signals enter.

### Gate open

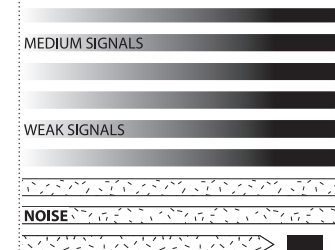

GATE  
OPEN

## Setting Squelch

### Gate closed

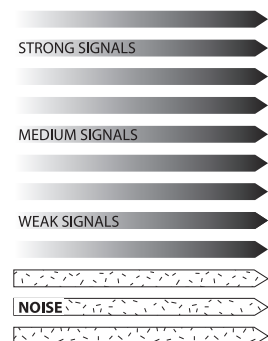

GATE  
CLOSED

## Setting Squelch

Squelch is the "control gate" for incoming signals.

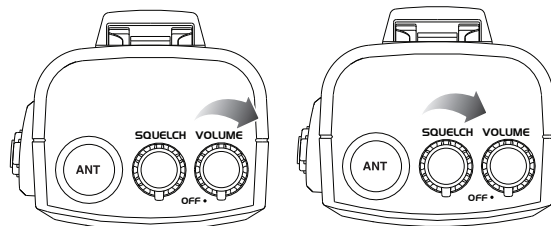

- Turn the volume up louder than normal.
- Fully *clockwise* closes the "gate", allowing no incoming signals.

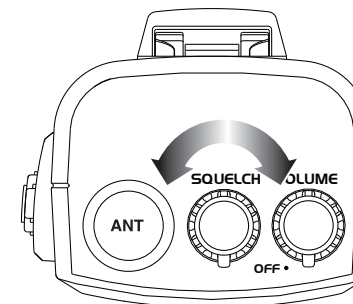

- To achieve the Desired Squelch Setting (DSS), turn the Squelch control *counterclockwise* until you hear noise. Now turn the control *clockwise* just until the noise stops. This is the DSS setting.

### Gate set to Desired Squelch Setting (DSS)

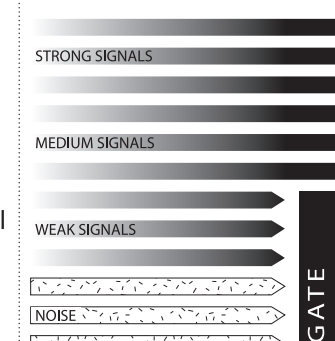

GATE

## Select a Channel

### Select a Channel

- 1 Turn power ON.
- 2 For higher channels, push UP arrow key.
- 3 For lower channels, push DOWN arrow key.

**Note**

For quick channel advance, push and hold arrow key(s).

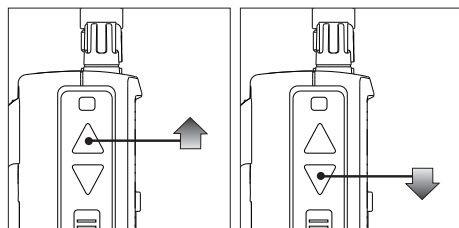
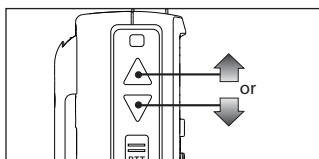

**Note**

When switching from one channel to another, squelch will need to be reset. See Setting Squelch on pages 4 and 5.

## LCD Display

All needed information is displayed on the LCD display panel.

## LCD Display

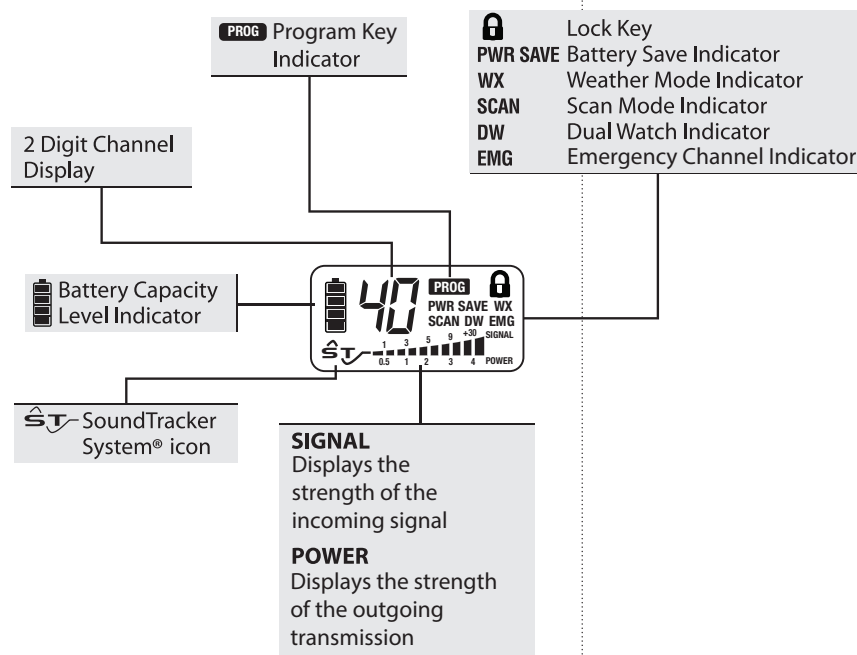

## Transmit/Receive

### Stop

Antenna must be installed before transmitting.

## Transmit / Receive

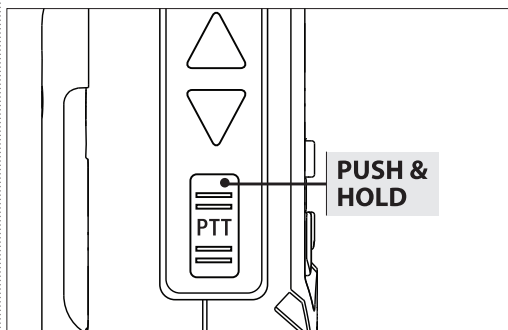

- 1 To transmit, *push and hold* PTT button.  
While the PTT button is depressed you cannot receive transmissions.

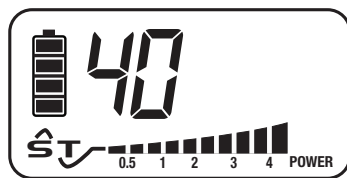

- 2 The TRANSMISSION POWER METER will be displayed when transmitting.  
During transmit, your outgoing transmission power is measured in watts and displayed on the power bar graph.

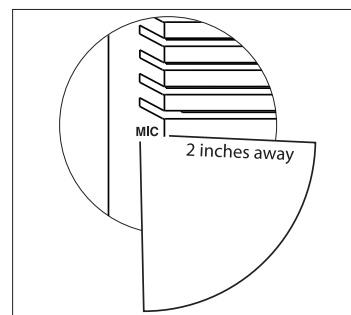

- 3 Hold the radio about 2 inches from your mouth. Speak in a normal voice.

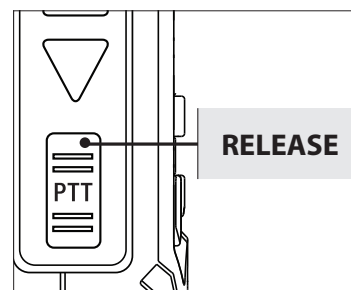

- 4 Release the PTT button to receive incoming transmissions.

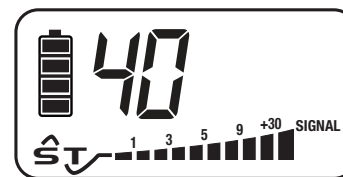

When you are receiving an incoming signal, the strength of that signal will be displayed on the SIGNAL STRENGTH METER.

### Note

Your HH50 WX ST is always ready to receive incoming signals when the PTT button is released.

## One Touch for Channel 9 and Channel 19

### One Touch For Channel 9 and Channel 19

To gain instant access to Channels 9 (emergency) and 19 (information) from other channels:

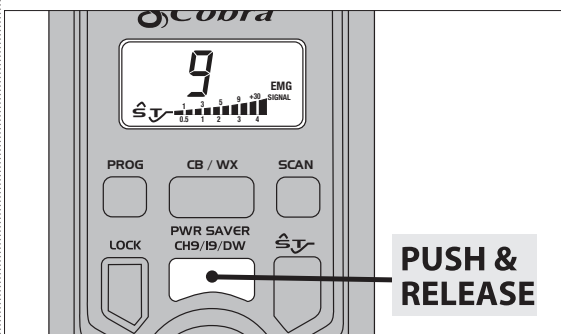

- 1 Push CH 9/19 once for channel 9.

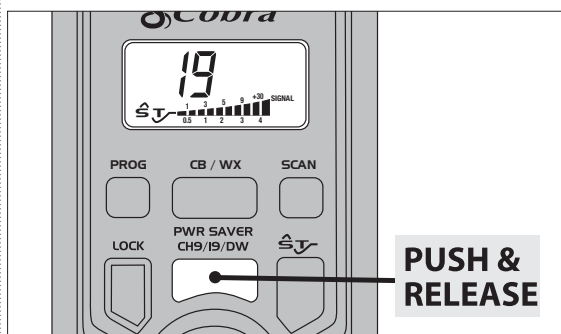

- 2 Push CH 9/19 again for Channel 19.

#### Note

Pressing CHANNEL UP/DOWN key will exit you from this mode.

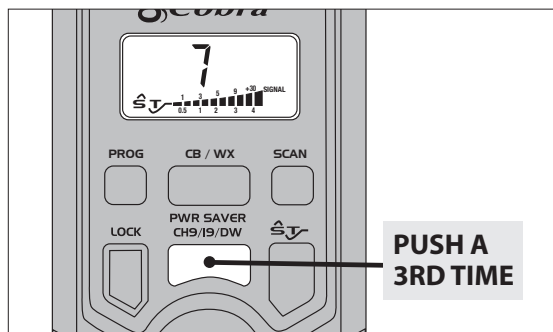

- 3 To return to the original channel, push CH 9/19 a third time.

### All Channel Scan

To scan all 40 channels:

- 1 Set Desired Squelch Setting (DSS).

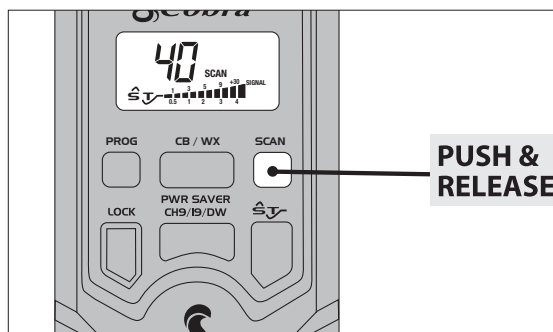

- 2 Push SCAN key. The channels will index.
- 3 To stop scanning, push SCAN key again.

### All Channel Scan

#### Note

When an incoming transmission is received the HH 50 WX ST will stop scanning.

10 seconds after the incoming signal stops, scanning will resume.

#### Note

To set Desired Squelch Setting (DSS) see Setting Squelch on pages 4 and 5.

Pressing the PTT key or scan key will terminate scan mode.



## Dual Watch

### Note

To set Desired Squelch Setting (DSS) see *Setting Squelch on pages 4 and 5.*

### Dual Watch

Dual Watch allows simultaneous monitoring of two user selected channels. For example, to monitor Channel 11 and 17 for incoming transmissions:

- 1 Set Desired Squelch Setting (DSS).
- 2 Select Channel 11 with CHANNEL UP/ DOWN key.

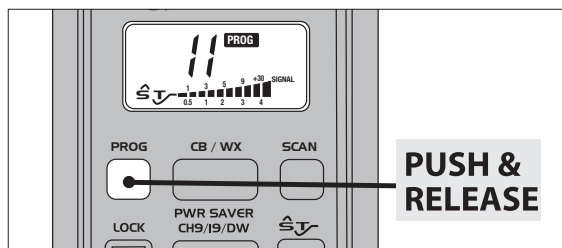

- 3 Push and release PROGRAM key.

PROGRAM icon will be displayed.

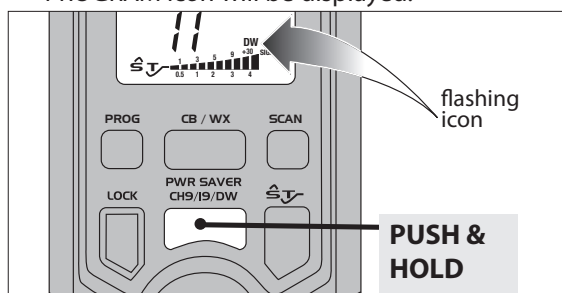

- 4 Push and hold PWR SAVER/CH9/19/DW key until "beep" is heard.

The DW icon will flash and the PROGRAM icon will disappear.

- 5 Select Channel 17 with CHANNEL UP/ DOWN key.

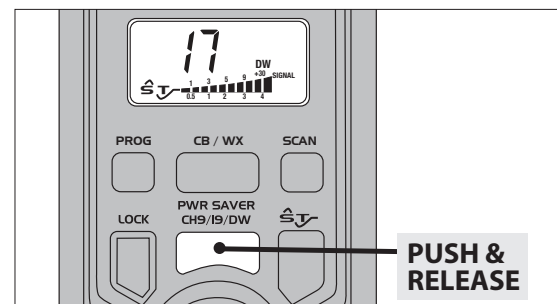

- 6 Push and release PWR SAVER/CH9/19/DW key, a "beep" will be heard.

The DW icon will stay on.

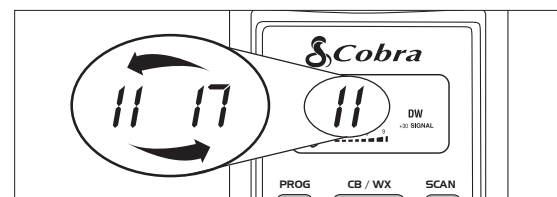

- 7 The HH 50 WX ST display will switch between the selected channels.
- 8 To stop dual watch, push CHANNEL UP/ DOWN key, or turn the radio off.

### Note

When a incoming transmission is received the HH 50 WX ST will stop monitoring and remain on the channel. After 10 seconds the radio will continue to monitor the 2 channels.

## Weather Channels

### Note

The 10 National Weather Channels include 7 NOAA and 3 Canadian channels. These channels provide full coverage to keep you informed of weather conditions, 24 hours a day, 7 days a week.

For a list of weather frequencies see specifications in the Frequency Ranges section on page 32.

### Note

Your HH 50 WX ST has a special auto squelch circuit for weather transmission which disables your squelch control.

## Weather Channels

10 National Weather Channels provide weather transmission reception.

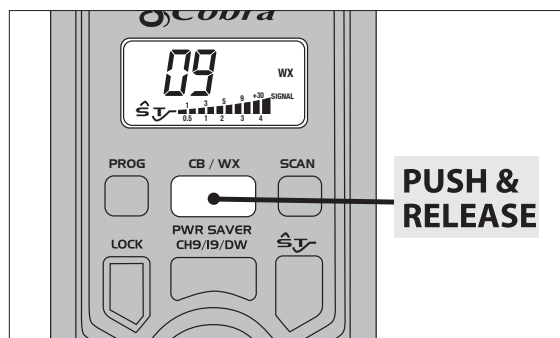

- 1 Push and release the CB/WX key and the current weather channel will appear.

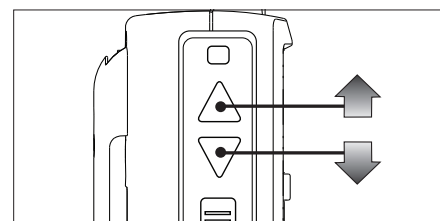

- 2 To change weather channels push the CHANNEL UP/DOWN arrow keys.

At times, different channels can be received. Select the one with the clearest audio quality.

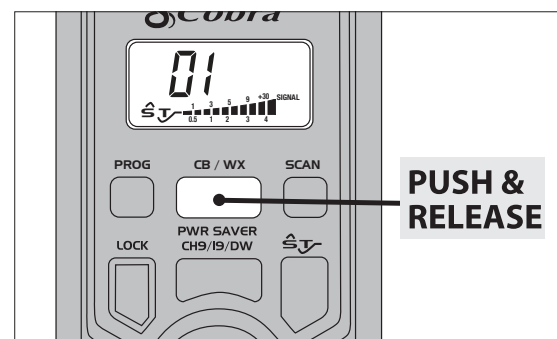

- 3 To return to normal CB operation, push and release the CB/WX key again.

The WX icon will disappear.

### Note

An agency of the U.S. Department of Commerce, NOAA operates 500 stations which reach about 90% of the U.S. population. If you cannot receive a weather station, you may not have one in your area.

If you wish to receive a listing of NOAA Weather Radio Transmitter locations, contact your nearest National Weather Service Office, or write to:

National Weather Service  
(Attn: W/OM11), NOAA  
Silver Spring, MD 20910

## Power Saver (HI/LOW)

## Power Saver (HI/LOW)

Reduces the transmit power output to 1 watt to extend the battery life.

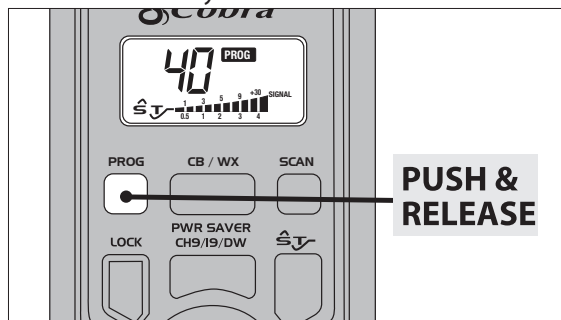

### Note

The low power setting cuts the transmitting range in half. The receiving range is not affected.

- 1 Push and release the PROGRAM key. PROGRAM icon will be displayed.

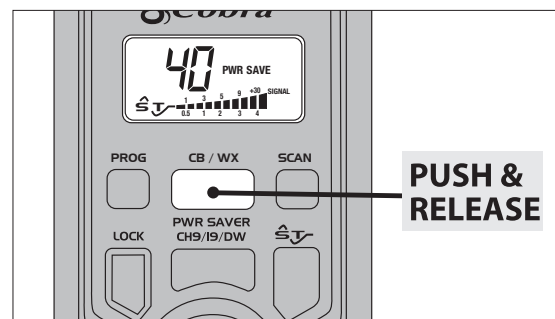

- 2 Push and release the CB/WX key.

The **PWR SAVE** icon will appear and the PROGRAM icon will disappear.

- 1 **To exit Power Saver (HI/LOW) mode:**

Push and release PROGRAM key.  
PROGRAM icon will be displayed.

- 2 Push and release the CB/WX PWR SAVER key.
- 3 PROGRAM and PWR SAVE icon will disappear

### Note

The battery life is increased approximately 50% while in Power Saver Mode.

## Battery Capacity Level

**Note**  
The radio does not transmit if the batteries are low.

### Battery Capacity Level

To monitor the remaining power level of the HH 50 WX ST battery: Check the battery icon bands.

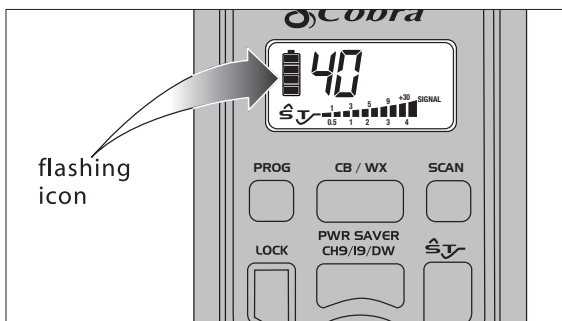

The BATTERY icon will flash if the batteries are low. Replace or recharge the batteries as soon as possible.

## The SoundTracker® System

While previous systems only “blanket out” or limit noise in higher sound frequencies, the revolutionary SoundTracker® System actually reduces noise while leaving the signal intact in the reception mode. In the transmission mode, it actually strengthens the signal, providing you with a significant reduction in noise on reception and transmission.

**Sound clarity is measured by the ratio of the signal level to the noise level. The higher the signal-to-noise ratio, the better the sound.**

### How SoundTracker® Works

*On Reception - “Cuts noise coming in”*

With a normal CB, distant signals fall below the squelch level and are unintelligible. With a SoundTracker® CB, the noise level is cut up to 90%, which increases the signal-to-noise ratio and dramatically improves signal clarity. This also allows you to significantly reduce the squelch level, which greatly expands your listening range.

*On Transmission - “Strengthens signals going out”*

A SoundTracker® CB strengthens the transmit signal by more effectively using the available RF power output of the CB. The result is improved transmission signal clarity and an expanded transmission range.



**Note**  
SoundTracker® gives you clearer, cleaner reception to improve CB communications while on the air.

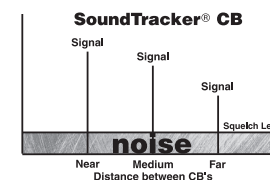
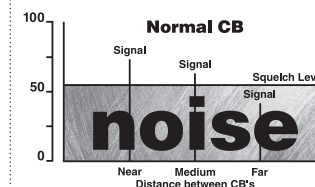

## Activating SoundTracker®

**Note**  
This engages the SoundTracker® system and reduces the incoming noise level.

### Activating SoundTracker®

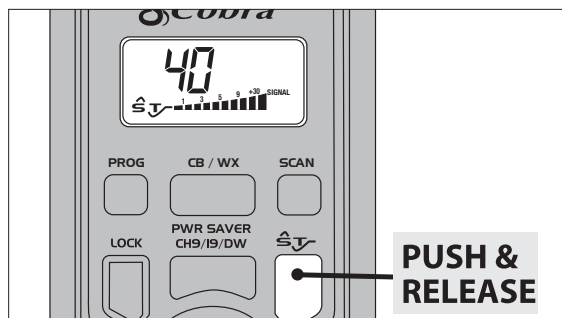

- 1 Push and release the ST key.

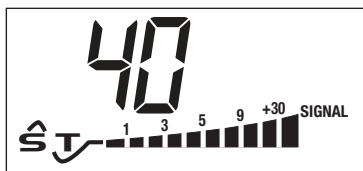

The SOUNDTRACKER icon will appear.

## Testing SoundTracker®

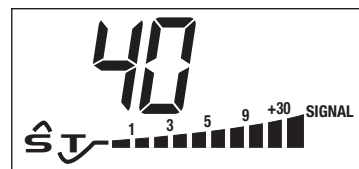

- 1 Select any unused channel on your CB.

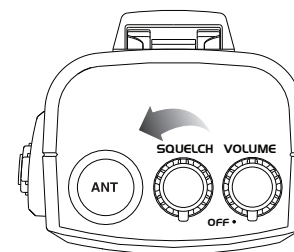

- 2 Fully counterclockwise opens the "gate" and all signals enter. Turn the knob clockwise until it stops.
- 3 Deactivate soundtrack mode by pressing the SOUNDTRACKER key.

continued

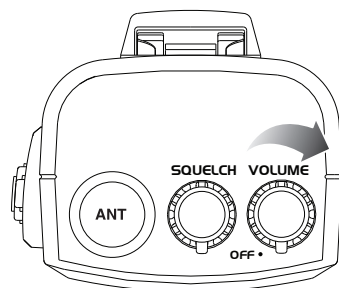

- 1 Turn the volume up louder than your normal listening level.

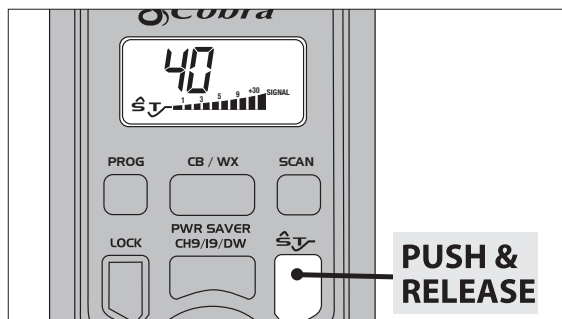

- 2 Push and release the ST key.

The SOUNDTRACKER icon will appear.  
\*Notice the significant reduction in noise.

### Note

At times you may experience different levels of noise reduction. Different terrains and environments will effect the SoundTracker® System's performance.

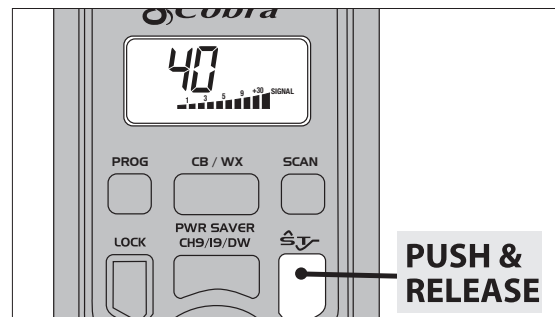

- 3 To disengage SoundTracker® push and release the ST key again.
- 4 ST icon will disappear.

### Lighted Display

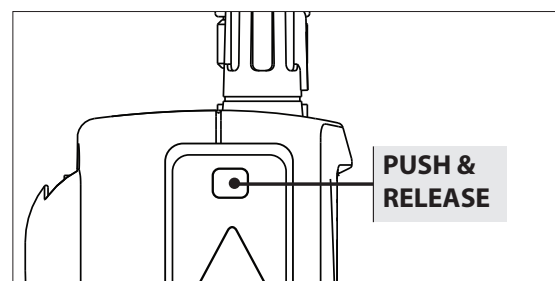

To illuminate the display, push and release the light key.

The light will remain on for about 10 seconds.

### Lighted Display

## Lock Key

### Note

PTT, LIGHT, VOLUME, SQUELCH and LOCK functions are still operational while the LOCK function is activated.

## Lock Key

The purpose is to lock the front keys to avoid accidental actuation.

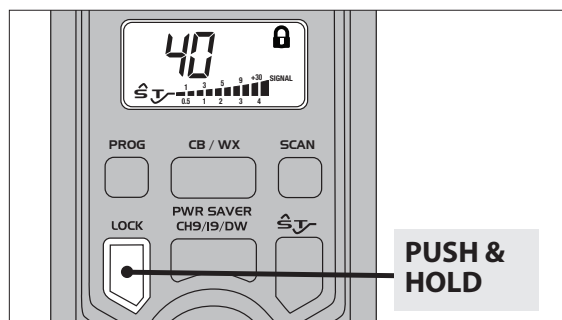

- 1 To lock, push and hold the LOCK key. The LOCK icon will appear.
- 2 To unlock, push and hold the LOCK key.

## In Vehicle Use

The HH 50 WX ST can be connected to your cigarette lighter port with the provided adapter. **This power connection will also charge the batteries with the included interchangeable tip.**

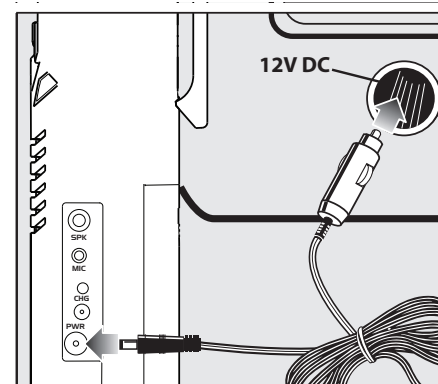

Connecting to power.

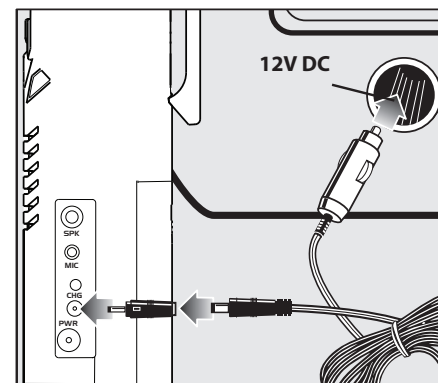

Charging using the interchangeable tip.

## In Vehicle Use

### Note

Due to the characteristics of CB transmissions, it is necessary to use an external car roof/truck magnet mounted antenna (item # HG A1000) and a BNC S0239 adapter (item # HA-BNC) to receive optimal performance while in your vehicle. See Accessories section on page 35.

### Note

The HH50RT Road trip model comes with a magnet mounted antenna (item #HH-Mini).

### SAFETY NOTICE MPE minimum distance for HH-Mini Antenna

The antenna used for this transceiver must be properly installed and maintained and must provide a separation distance of at least 12 inches (31 cm) from all persons and must not be co-located or operated in conjunction with any other antenna or transmitter. Never transmit if any person is closer than the specified distance to the antenna.

## A Few Rules You Should Know

### A CB Radio Can:

- Warn of traffic problems
- Provide weather and road data
- Provide help in event of an emergency
- Provide direct contact with home or office
- Assist police by reporting erratic drivers
- Get local information to find a destination
- Communicate with family and friends
- Suggest spots to eat and sleep
- Keep you alert while traveling

### A Few Rules You Should Know

- A. Conversations cannot last more than 5 minutes with another station. A one minute break is required to let others use the channel.
- B. You cannot blast others off the air by use of illegally amplified transmitters or illegally high antennas.
- C. You cannot use a CB to promote illegal activities.
- D. Profanity is not allowed.
- E. You may not transmit music with a CB.
- F. Selling of merchandise and/or services is prohibited.

### Weather Channel Messages

Local weather reports are provided by NOAA (National Oceanic Atmospheric Administration) 24 hours a day, 7 days a week. An agency of the U. S. Department of Commerce, NOAA operates 500 stations which reach about 90% of the U. S. population. If you cannot receive a weather station, you may not have one in your area. A similar network of 15 stations broadcasts continuous weather information across much of southern Canada.

### Weather Channel Messages

#### Note

*If you wish to receive a listing of NOAA Weather Radio Transmitter locations, contact your nearest National Weather Service Office, or write to:*

*National Weather Service  
(Attn: W/OM11), NOAA  
Silver Spring, MD 20910*

*For a list of weather frequencies see specifications in the Frequency Ranges section on page 32.*



# How Your CB Can Serve You

## Channel 9 Emergency Messages

**Note**  
If there is no response on channel 9, try channels 19 or 14.

### Channel 9 Emergency Messages

#### 1. Set to channel 9 for emergencies

Be sure the antenna is properly connected.

#### 2. CB Distress Data

When transmitting an emergency, you should request a "REACT BASE" and provide the CB distress data (called **CLIP**):

- C** all Sign *Identify yourself.*
- L** ocation *Be exact.*
- I** njuries *Number. Type. Trapped?*
- P** roblem *Give details and help needed.*

Transmit **CLIP** repeatedly so any monitor can assist.

# How Your CB Can Serve You

The FCC gives these examples of permitted and prohibited messages for channel 9. These are only guidelines and not all-inclusive:

Permitted	Example Message
Yes	"Tornado sighted six miles north of town."
No	"Post number 10. No tornado sighted."
Yes	"Out of gas on I-95 at mile marker 211."
No	"Out of gas in my driveway."
Yes	"Four car accident on I-94 at Exit 11. Send police and ambulance."
No	"Traffic moving smoothly on I-94."
Yes	"Weather Bureau has issued thunderstorm warning. Bring sailboat into port."
No	"Attention motorists. Weather Bureau advises snow tomorrow will accumulate 4 to 6 inches."
Yes	"Fire in building at 539 Main, Evanston."
No	"Halloween patrol number 3. All quiet."

# How Your CB Can Serve You

# How Your CB Can Serve You

## CB 10-Codes

### CB 10-Codes

Citizen Bands have adopted the "10-CODES" for standard questions and answers. These codes provide quick and easy communication, especially in noisy areas. Following are some of the more common codes and meanings:

Code	Meaning
10-1	Receiving poorly
10-2	Receiving well
10-3	Stop transmitting
10-4	OK, message received
10-5	Relay message
10-6	Busy, stand by
10-7	Out of service, leaving
10-8	In service, subject to call
10-9	Repeat message
10-10	Transmission completed standing by
10-11	Talking too rapidly
10-12	Visitors present
10-13	Advise weather/roads
10-16	Make pick up at
10-17	Urgent business
10-18	Anything for us?
10-19	Return to base
10-20	My location is
10-21	Call by phone
10-22	Report in person to
10-23	Stand by
10-24	Completed last assignment
10-25	Can you contact
10-26	Disregard last info
10-27	Moving to channel
10-28	Identify your station

Code	Meaning
10-29	Time is up for contact
10-30	Does not conform to FCC rules
10-33	Emergency traffic
10-34	Trouble at this station
10-35	Confidential information
10-36	Correct time is
10-37	Wrecker needed at
10-50	Ambulance needed
10-39	Message delivered
10-41	Turn to channel
10-42	Traffic accident at
10-43	Traffic tie up at
10-44	Have a message for
10-45	All units within range please report
10-50	Break channel
10-60	What is next message number?
10-62	Unable to copy. Use phone
10-63	Net directed to
10-64	Net clear
10-65	Awaiting your next message/assignment
10-67	All units comply
10-70	Fire at
10-71	Proceed, transmission in sequence
10-77	Negative contact
10-81	Reserve hotel room for
10-82	Reserve room for
10-85	My address is
10-91	Talk closer to mic
10-93	Check my frequency on this channel
10-94	Give me a long count
10-99	Mission completed, all units secure
10-200	Police needed at

# Frequency Ranges

# HH50 WX ST Specifications

The COBRA HH 50 WX ST transceiver represents one of the most advanced AM two-way radios used as a Class D station in the Citizens Band Radio Service. This unit features advanced Phase Lock Loop (PLL) circuitry providing complete coverage of all 40 CB channels and 10 weather channels as shown below.

CB Channel	Channel Freq. In MHz	CB Channel	Channel Freq. In MHz	Weather Channel	Weather Freq. In MHz
1	26.965	21	27.215	1	162.550
2	26.975	22	27.225	2	162.400
3	26.985	23	27.255	3	162.475
4	27.005	24	27.235	4	162.425
				5	162.450
5	27.015	25	27.245	6	162.500
6	27.025	26	27.265	7	162.525
7	27.035	27	27.275	8	161.650
8	27.055	28	27.285	9	161.775
9	27.065	29	27.295	00	163.275
10	27.075	30	27.305		
				<i>*Canadian weather channels are 8, 9 and 00.</i>	
11	27.085	31	27.315		
12	27.105	32	27.325		
13	27.115	33	27.335		
14	27.125	34	27.345		
15	27.135	35	27.355		
16	27.155	36	27.365		
17	27.165	37	27.375		
18	27.175	50	27.505		
19	27.185	39	27.395		
20	27.205	40	27.405		

**GENERAL**

CHANNELS	CB - 40 CH WEATHER - 10 CH
FREQUENCY RANGE	CB - 26.965 TO 27.405 MHZ WEATHER - 161.650 TO 163.275 MHZ
FREQUENCY TOLERANCE	0.005 %
FREQUENCY CONTROL	PLL (PHASE LOCK LOOP) SYNTHESIZER
OPERATING TEMPERATURE RANGE	-30° C TO + 50° C
MICROPHONE	ELECTRET, PUSH-TO-TALK
INPUT VOLTAGE	13.5 VDC (INTERNAL 9AA BATTERIES) 13.8 VDC, EXTERNAL
ANTENNA CONNECTOR	BNC
METER	LCD DISPLAY, ICONS
WEIGHT	10.02 oz. without batteries 15.09 oz. with batteries

**TRANSMITTER**

POWER OUTPUT	4.0 W AT 13.8 VDC - HIGH, 1.0W - LOW
MODULATION	AM
FREQUENCY RESPONSE	300 - 3000 HZ AT -6 dB
OUTPUT IMPEDANCE	50 OHMS, UNBALANCED

**RECEIVER**

CB SENSITIVITY	LESS THAN 1 uV FOR 10 dB S/N
IF	DUAL CONVERSION SUPERHETERODYNE
AUDIO OUTPUT	400 mW MAXIMUM AT 10% DISTORTION
FREQUENCY RESPONSE	300 - 3000 HZ AT -6 dB
2ND IF IMAGE REJECTION	GREATER THAN 60 dB
ADJACENT CH. REJECTION	50 DB MIN.
AUTOMATIC NOISE LIMITER	BUILT- IN
FREQUENCY CONTROL	PLL (PHASE LOCK LOOP)

**WEATHER**

SENSITIVITY	LESS THAN 1 uV FOR 12 dB SINAD
IF FREQUENCY	DUAL CONVERSION SUPERHETERODYNE
AUDIO OUTPUT	MAXIMUM 400 mW AT 10% DISTORTION
FREQUENCY RESPONSE	300 - 3000 HZ AT -6 dB

## Limited Two Year Warranty

## Optional Accessories

**COBRA ELECTRONICS CORPORATION** warrants that its COBRA CB Radios, and the component parts thereof, will be free of defects in workmanship and materials for period of two (2) years from the date of first consumer purchase. This warranty may be enforced by the first consumer purchaser, provided that the product is utilized within the U.S.A.

COBRA will, without charge, repair or replace, at its option, defective CB radios, products or component parts upon delivery to the COBRA factory Service Department, accompanied by proof of the date of first consumer purchase, such as a duplicated copy of a sales receipt.

You must pay any initial shipping charges required to ship the product for warranty service, but the return charges will be at Cobra's expense, if the product is repaired or replaced under warranty.

**Exclusions:** This limited warranty does not apply; 1) to any product damaged by accident; 2) in the event of misuse or abuse of the product or as a result of unauthorized alterations or repairs; 3) if the serial number has been altered, defaced or removed; 4) if the owner of the product resides outside the U.S.A.

**All implied warranties, including warranties of merchantability and fitness for a particular purpose are limited in duration to the length of this warranty. COBRA shall not be liable for any incidental, consequential or other damages; including, without limitation, damages resulting from loss of use or cost of installation.**

**Some states do not allow limitations on how long an implied warranty lasts and/or do not allow the exclusion or limitation of incidental or consequential damages, so the above limitations may not apply to you.**



**Ear Bud Mic with PTT**

*Integrated speaker/mic adapter that fits in your ear. Includes shirt clip.*  
PMR-EBM



**120 Volt A/C Wall Charger with Plug**

*Charges 9 NiMH battery cells in 24 hours right in the unit.*  
CA-45CB

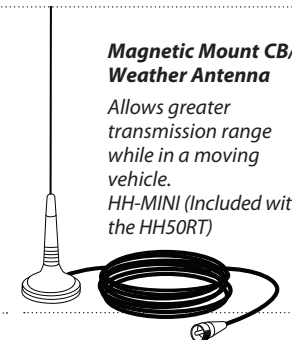

**Magnetic Mount CB/Weather Antenna**

*Allows greater transmission range while in a moving vehicle.*  
HH-MINI (Included with the HH50RT)

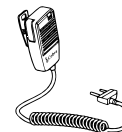

**Lapel Microphone**

*Remote microphone/speaker connection.*  
PMR-SM



**BNC/SO239 Antenna Adapter**

*Allows connection of the HH 50 WX ST to standard antennas.*  
HA-BNC

**Long Range Antenna**

*Doubles the range of your HH 50 WX ST.*  
HA-TA



**(1) High Performance NiMH Rechargeable Battery Cell**

212-001-N-001

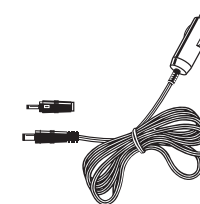

**Replacement DC Power Cord with Charge Adapter**

*To charge rechargeable batteries or in-vehicle use.*  
HH50-CIG

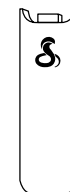

**Replacement Belt Clip**

HA-BC1

### Cobra Electronics Corporation

6500 West Cortland Street  
Chicago, Illinois 60707  
www.cobra.com

# FCC

## FCC Part 15.19 Warning Statement- (Required for all Part 15 devices)

THIS DEVICE COMPLIES WITH PART 15 OF THE FCC RULES. OPERATION IS SUBJECT TO THE FOLLOWING TWO CONDITIONS: (1) THIS DEVICE MAY NOT CAUSE HARMFUL INTERFERENCE, AND (2) THIS DEVICE MUST ACCEPT ANY INTERFERENCE RECEIVED, INCLUDING INTERFERENCE THAT MAY CAUSE UNDESIRE OPERATION.

## FCC Part 15.21 Warning Statement-

**NOTE:** THE GRANTEE IS NOT RESPONSIBLE FOR ANY CHANGES OR MODIFICATIONS NOT EXPRESSLY APPROVED BY THE PARTY RESPONSIBLE FOR COMPLIANCE. SUCH MODIFICATIONS COULD VOID THE USER'S AUTHORITY TO OPERATE THE EQUIPMENT.

## FCC Part 15.105(b) Warning Statement

**NOTE:** This equipment has been tested and found to comply with the limits for a Class B digital device, pursuant to part 15 of the FCC Rules. These limits are designed to provide reasonable protection against harmful interference in a residential installation. This equipment generates uses and can radiate radio frequency energy and, if not installed and used in accordance with the instructions, may cause harmful interference to radio communications. However, there is no guarantee that interference will not occur in a particular installation. If this equipment does cause harmful interference to radio or television reception, which can be determined by turning the equipment off and on, the user is encouraged to try to correct the interference by one or more of the following measures:

- Reorient or relocate the receiving antenna.
- Increase the separation between the equipment and receiver.
- Connect the equipment into an outlet on a circuit different from that to which the receiver is connected.
- Consult the dealer or an experienced radio/TV technician for help.

## IC RSS-GEN, Sec 8.4 Warning Statement

This device complies with Industry Canada license-exempt RSS standard(s). Operation is subject to the following two conditions: (1) this device may not cause interference, and (2) this device must accept any interference, including interference that may cause undesired operation of the device.

Le présent appareil est conforme aux CNR d'Industrie Canada applicables aux appareils radio exempts de licence. L'exploitation est autorisée aux deux conditions suivantes : (1) l'appareil ne doit pas produire de brouillage, et (2) l'utilisateur de l'appareil doit accepter tout brouillage radioélectrique subi, même si le brouillage est susceptible d'en compromettre le fonctionnement.

## IC RSS-GEN, Sec 8.3 Warning Statement

This radio transmitter, 906A-HH50WXST, has been approved by Industry Canada to operate with the antenna types listed below with the maximum permissible gain and required antenna impedance for each antenna type indicated. Antenna types not included in this list, having a gain greater than the maximum gain indicated for that type, are strictly prohibited for use with this device.

Antennas approved for use with HH50WXST:

Model	Gain	Impedance
HH-ANT	-5 dBi	50Ω
HG-TA	-3 dBi	50Ω
HH-MINI	0 dBi	50Ω

Le présent émetteur radio (identifier le dispositif par son numéro de certification ou son numéro de modèle s'il fait partie du matériel de catégorie I) a été approuvé par Industrie Canada pour fonctionner avec les types d'antenne énumérés ci-dessous et ayant un gain admissible maximal et l'impédance requise pour chaque type d'antenne. Les types d'antenne non inclus dans cette liste, ou dont le gain est supérieur au gain maximal indiqué, sont strictement interdits pour l'exploitation de l'émetteur.